

DEVELON

Road Builder

DX300LL-5



Engine

Make	DEVELON
Model	DL08P
Number of cylinders	6
Rated power, gross (hp per SAE J1995)	270.9 hp (202 kW) @ 1800 rpm
Rated power, net (hp per SAE J1349)	266.7 hp (198 kW) @ 1800 rpm
Max. torque, gross (SAE J1995)	940 lbf.ft. (130 kgf.m) @ 1300 rpm
Piston displacement	466 in. ³ (7.64 L)
Bore and stroke	4.25 in. x 5.47 in. (108 mm x 139 mm)
Starter	24 V, 8.0 hp (6.0 kW)
Battery (qty. 2)	2 x 12 V, 150 AH
Alternator	24 V, 80 A
Air cleaner	Double elements

Hydraulics

Main pumps	2 x 65.5 gpm (2 x 248 L/min.)
Pilot pump (gear design)	7.1 gpm (27 L/min.)

Maximum System Pressure

Boom/arm/bucket (normal)	4978 psi (350 kg/cm ²)
Boom/arm/bucket (power boost)	5262 psi (370 kg/cm ²)
Travel (normal)	4978 psi (350 kg/cm ²)
Swing (normal)	4978 psi (350 kg/cm ²)

Undercarriage

Upper rollers (each track)	2
Lower rollers (each track)	9
Number of shoes (links per side)	48
Total length of track	16' 2" (4920 mm)

Swing Mechanism

Swing speed	0 – 9.8 rpm
Swing torque	87786 lbf.ft. (12137 kgf.m)

Drive System

Travel speed (low – high)	1.7 – 2.6 mph (2.8 – 4.3 km/h)
Traction force (drawbar pull)	78705 lbf. (35700 kgf)
Max. grade (limited by engine lubrication)	70% (35°)

Environment

Sound level (2000/14/EC)	104 dB(A)
Cabin sound level (ISO 6396)	69 dB(A)

Refill Capacities

Fuel tank	132 gal. (500 L)
DEF tank	16.6 gal. (63 L)
Cooling system	13.4 gal. (50.9 L)
Engine oil	11 gal. (42 L)
Swing reduction unit	1.8 gal. (7 L)
Final drive (each side)	2 x 1.6 gal. (2 x 6 L)
Hydraulic system	73.9 gal. (280 L)
Hydraulic tank	43.5 gal. (165 L)

Hydraulic Cylinders

Boom (2) bore x rod diameter x stroke	5.5 in. x 3.74 in. x 56.7 in. (140 mm x 95 mm x 1440 mm)
Arm (1) bore x rod diameter x stroke	5.9 in. x 4.13 in. x 63.9 in. (150 mm x 105 mm x 1625 mm)
Bucket (1) bore x rod diameter x stroke	5.3 in. x 3.54 in. x 45.2 in. (135 mm x 90 mm x 1150 mm)

The piston rods and cylinder bodies are made of high-strength steel. A shock-absorbing mechanism is fitted in all cylinders to ensure shock-free operation and extended piston life.

Dimensions

		Road Builder Standard Cab (US30)	Road Builder Oregon Cab (US35)
Boom length		20' 6" (6245 mm)	
Arm length		10' 2" (3100 mm)	
Bucket		1.38 yd ³ (1.60 m ³)	
Track type		2' 4" (700 mm) DG track shoe	
Tail swing radius	A ₁	11' 8" (3559 mm)	
Tail swing overhang (rear)	A ₂	3' 7" (1099 mm)	
Tail swing overhang (side)	A ₃	5' 10" (1779 mm)	
Shipping height**	B	12' 1" (3689 mm)	
Shipping length	C	35' 11" (10958 mm)	
Shipping width	D	11' 10" (3600 mm)	
Counterweight clearance**	E	4' 10" (1473 mm)	
Cabin height**	F	11' 1" (3381 mm)	12' 1" (3695 mm)
Cab riser*		-	
Upper structure width	G	12' 0" (3576 mm)	
Cabin height above house	H	2' 2" (853 mm)	3' 10" (1170 mm)
Cabin width	I	3' 4" (1010 mm)	3' 9" (1140 mm)
Cabin guarding width*		3' 4" (1010 mm)	3' 9" (1140 mm)
Tumbler distance	J	13' 2" (4010 mm)	
Overall track length	K	16' 2" (4920 mm)	
Undercarriage width	L	11' 10" (3600 mm)	
Track gauge width	M	9' 5" (2900 mm)	
Track shoe width	N	2' 4" (700 mm)	
Track height**	O	3' 11" (1189 mm)	
Car body clearance**	P	2' 6" (760 mm)	
Cabin tilting angle*		-	

*Not shown on diagram

**Without shoe grouser

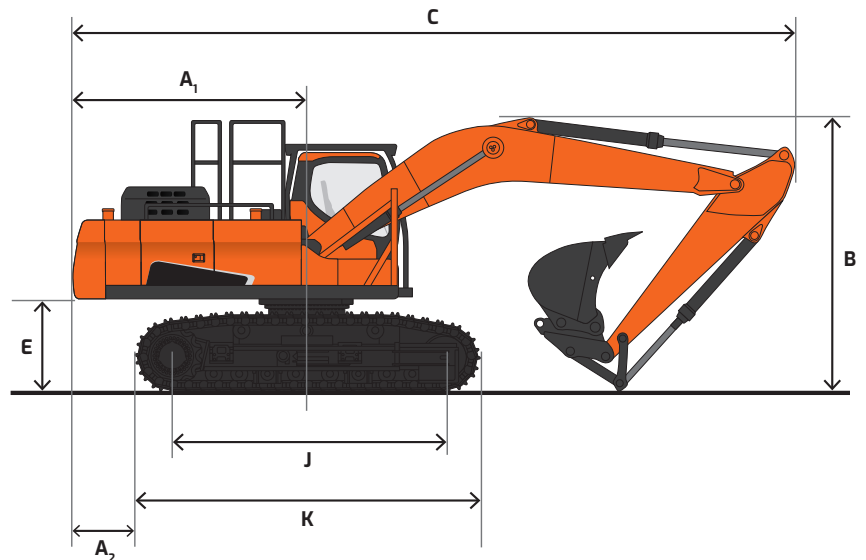
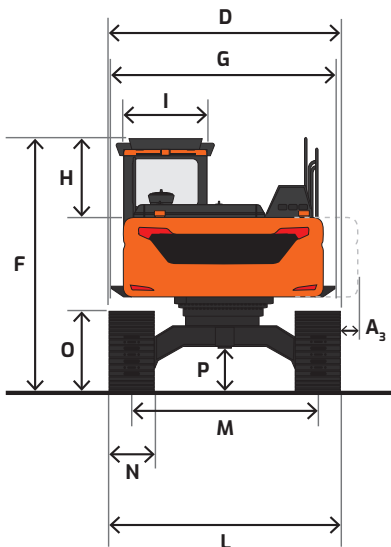

Working Range

		Log Loader ROPS Cab with FOG (U530)	Road Builder Forestry Cab (U535)
Boom length		20' 6" (6245 mm)	
Arm length		10' 2" (3100 mm)	
Bucket capacity		2.09 yd ³ (1.60 m ³)	
Track type		28" (700 mm) Double grouser shoes	
Max. digging reach*	A	35' 1" (10670 mm)	
Max. digging reach (ground)*	B	34' 3" (10420 mm)	
Max. digging depth*	C	19' 6" (5950 mm)	
Max. loading height*	D	28' 3" (8620 mm)	
Max. depth to 8' line*	E	19' 0" (5780 mm)	
Min. swing radius*	F	9' 10" (3005 mm)	
Operating weight		81364 lb. (36906 kg)	
Ground pressure		8.53 psi (0.60 kg/cm ²)	

*High-lift

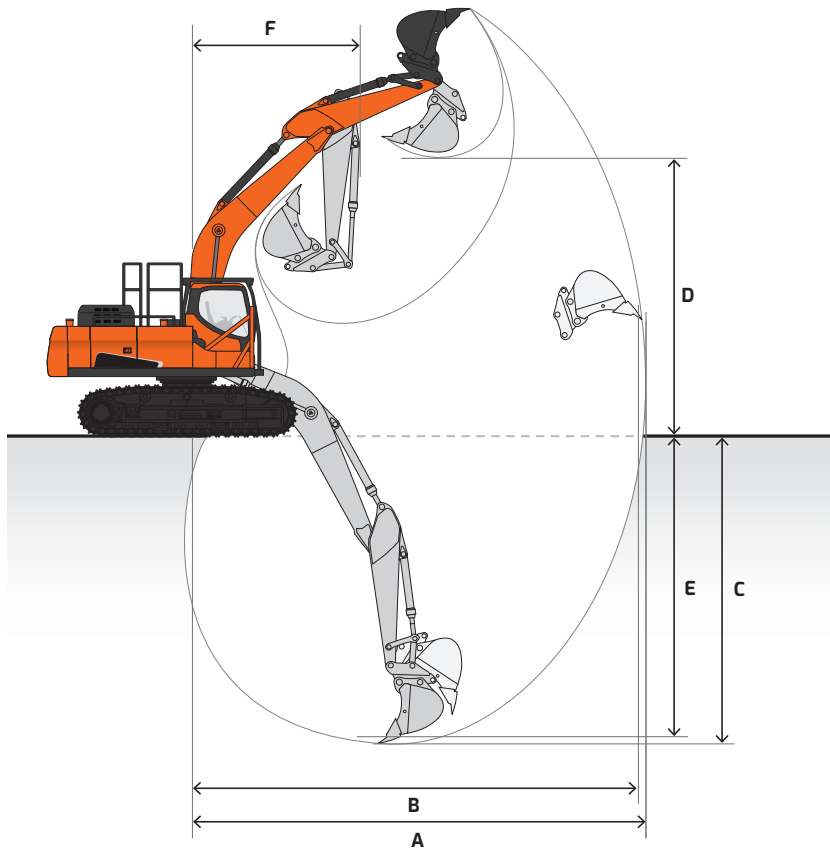















Lifting Capacity

 Rating over front  Rating over side or 360°

DX300LL-5 Road Builder US35 | Oregon Cab

Boom: 20' 5" (6245 mm) | Arm: 10' 2" (3100 mm) | Counterweight: 13888.98 lb. (6300 kg) | 28" (700 mm) DG Shoes | Bucket: None | Unit: lb. (kg)

A (ft. or m) B (ft. or m)	5' (1.5 m)		10' (3.0 m)		15' (4.5 m)		20' (6.0 m)		25' (7.5 m)		25' (7.5 m)		Max. Reach		
															A
25' (7.5 m)													* 10280 (* 4660)	* 10280 (* 4660)	24.46' (7.46 m)
20' (6.0 m)													* 9960 (* 4520)	* 9960 (* 4520)	27.29' (7.46 m)
15' (4.5 m)			* 29020 (* 13160)	* 29020 (* 13160)	* 19230 (* 8720)	* 19230 (* 8720)	* 15670 (* 7110)	* 15670 (* 7110)	* 14000 (* 6350)	* 14000 (* 6350)			* 10040 (* 4550)	* 10040 (* 4550)	29.02' (8.84 m)
10' (3.0 m)					* 25150 (* 11410)	* 25150 (* 11410)	* 18520 (* 8400)	* 18520 (* 8400)	* 15480 (* 7020)	* 15480 (* 7020)	* 11960 (* 5420)	* 11960 (* 5420)	* 10470 (* 4750)	* 10470 (* 4750)	29.83' (9.09 m)
5' (1.5 m)					* 29640 (* 13450)	* 29640 (* 13450)	* 21120 (* 9580)	* 21120 (* 9580)	* 16950 (* 7690)	* 16950 (* 7690)	* 12906 (* 5880)	* 12906 (* 5880)	* 11300 (* 5130)	* 11300 (* 5130)	29.81' (9.09 m)
Ground Level			* 15270 (* 6930)	* 15270 (* 6930)	* 31620 (* 14340)	* 31620 (* 14340)	* 22810 (* 10350)	* 22810 (* 10350)	* 18010 (* 8170)	16730 (7590)			* 12730 (* 5770)	* 12730 (* 5770)	28.95' (8.82 m)
-5' (-1.5 m)	* 19020 (* 8630)	* 19020 (* 8630)	* 26390 (* 11970)	* 26390 (* 11970)	* 31600 (* 14330)	* 31600 (* 14330)	* 23310 (* 10570)	22630 (10270)	* 18260 (* 8280)	16610 (7530)			* 15220 (* 6990)	14570 (6610)	27.18' (8.28 m)
-10' (-3.0 m)	* 29720 (* 13480)	* 29720 (* 13480)	* 40280 (* 18270)	* 40280 (* 18270)	* 29780 (* 13510)	* 29780 (* 13510)	* 22290 (* 10110)	* 22290 (* 10110)					* 17140 (* 7770)	17100 (7760)	24.29' (7.40 m)
-15' (-4.5 m)			* 35130 (* 15930)	* 35103 (* 15930)	* 25320 (* 11490)	* 25320 (* 11490)	* 18200 (* 8250)	* 18200 (* 8350)					* 18020 (* 8170)	* 18020 (* 8170)	19.79' (6.03 m)

A Distance from center of rotation
B Height

NOTE: Lifting capacities are in compliance with ISO 10567. Lift capacities apply only to the machine as originally manufactured and normally equipped by the manufacturer. Load point is the end of the heel to grapple pin. Rated loads shown do not exceed 75% of minimum tipping loads or 87% of hydraulic capacities. Rated loads marked with an asterisk (*) are limited by hydraulic capacities. The least stable position is over the side. The total mass of machine includes the mass of the boom, arm, counterweight, all operating fluids and 165 lb. (75 kg) operator.

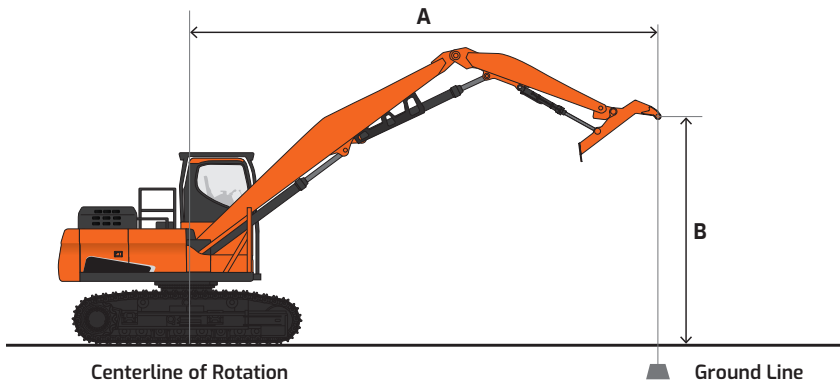















Lifting Capacity

 Rating over front  Rating over side or 360°

DX300LL-5 Road Builder US30 | ROPS Cab

Boom: 20' 5" (6245 mm) | Arm: 10' 2" (3100 mm) | Counterweight: 13888.98 lb. (6300 kg) | 28" (700 mm) DG Shoes | Bucket: None | Unit: lb. (kg)

A (ft. or m) B (ft. or m)	5' (1.5 m)		10' (3.0 m)		15' (4.5 m)		20' (6.0 m)		25' (7.5 m)		25' (7.5 m)		Max. Reach		
															A
25' (7.5 m)													* 11000 (* 4990)	* 11000 (* 4990)	24.46' (7.46 m)
20' (6.0 m)										* 13960 (* 6330)	* 13960 (* 6330)		* 10650 (* 4830)	* 10650 (* 4830)	27.29' (7.46 m)
15' (4.5 m)			* 31130 (* 14120)	* 31130 (* 14120)	* 20670 (* 9370)	* 20670 (* 9370)	* 16870 (* 7650)	* 16870 (* 7650)	* 15100 (* 6850)	* 15100 (* 6850)			* 10740 (* 4870)	* 10740 (* 4870)	29.02' (8.84 m)
10' (3.0 m)					* 27005 (* 12270)	* 27005 (* 12270)	* 19950 (* 9050)	* 19950 (* 9050)	* 16700 (* 7570)	* 16700 (* 7570)	* 12780 (* 5800)	* 12780 (* 5800)	* 11200 (* 5080)	* 11200 (* 5080)	29.83' (9.09 m)
5' (1.5 m)					* 31890 (* 14470)	* 31890 (* 14470)	* 22750 (* 10320)	* 22750 (* 10320)	* 18280 (* 8290)	* 18280 (* 8290)	* 13850 (* 6280)	* 13110 (5950)	* 12090 (* 5480)	* 12090 (* 5480)	29.81' (9.09 m)
Ground Level			* 16110 (* 7310)	* 16110 (* 7310)	* 34010 (* 15430)	* 34010 (* 15430)	* 24570 (* 11150)	24570 (11150)	* 19420 (* 8810)	19420 (8810)			* 13600 (* 6170)	13330 (6050)	28.95' (8.83 m)
-5' (-1.5 m)	* 20080 (* 9110)	* 20080 (* 9110)	* 27900 (* 12660)	* 27900 (* 12660)	* 34000 (* 15420)	* 34000 (* 15420)	* 25110 (* 10890)	25110 (10890)	* 19690 (* 8930)	19690 (8930)			* 16250 (* 7370)	14510 (6580)	27.18' (8.28 m)
-10' (-3.0 m)	* 31440 (* 14260)	* 31440 (* 14260)	* 42640 (* 19340)	* 42640 (* 19340)	* 32060 (* 14540)	* 32060 (* 14540)	* 24020 (* 10890)	24020 (10890)					* 18490 (* 8390)	17030 (7730)	24.29' (7.40 m)
-15' (-4.5 m)			* 37850 (* 17170)	* 37850 (* 17170)	* 27300 (* 12380)	* 27300 (* 12380)	* 19650 (* 8910)	* 19650 (* 8910)					* 19450 (* 8820)	* 19450 (* 8820)	19.79' (6.03 m)

A Distance from center of rotation
B Height

NOTE: Lifting capacities are in compliance with ISO 10567. Lift capacities apply only to the machine as originally manufactured and normally equipped by the manufacturer. Load point is the end of the heel to grapple pin. Rated loads shown do not exceed 75% of minimum tipping loads or 87% of hydraulic capacities. Rated loads marked with an asterisk (*) are limited by hydraulic capacities. The least stable position is over the side. The total mass of machine includes the mass of the boom, arm, counterweight, all operating fluids and 165 lb. (75 kg) operator.

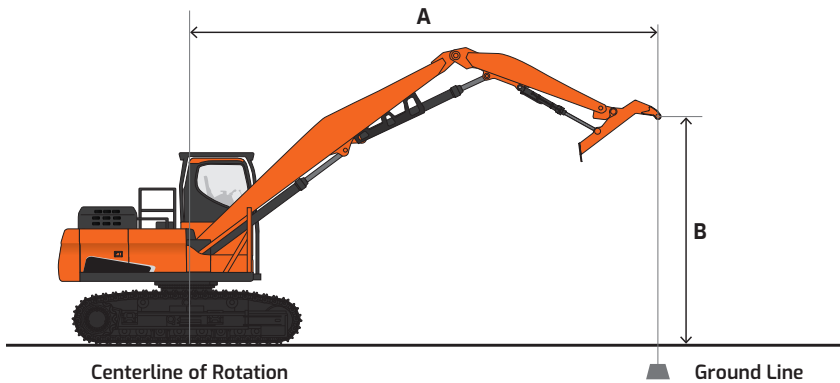

Standard & Optional Equipment

Standard Base Package, US20

■ Standard ● Optional – N/A

Engine

Emissions (EPA)	T4
High-pressure common-rail (HPCR)	■
Turbo, variable geometry (VGT)	■
Cooled exhaust gas recirculation (CEGR)	■
Diesel oxidation catalyst (DOC)	■
Exhaust brake	■
Selective catalyst reduction (SCR)	■
Diesel exhaust fluid (DEF)	■
Fuel filter with water separator	■
Coolant recovery tank	■
Dual element dry-type air filter with evacuator	■
Precleaner	■
Electronic engine control (ECU)	■
Auto idle	■
Auto shutdown (time-adjustable)	■
Overheat & low oil pressure engine protection	■
Block heater (110 V)	●
Block heater (220 V)	●
Fuel filler pump	●

Hydraulic

Mechatronics Design	■
Variable axial piston main pump (tandem)	■
Cross-sensing pump control	■
Pilot-operated control valves	■
Gear pilot pump	■
Variable-speed hydraulic cooling fan	■
Axial piston swing motor	■
Swing drive with spring applied hydraulic release brake	■
Axial piston travel motor (high/low, auto)	■
Auxiliary hydraulics, two-way piping	■
Auxiliary hydraulics, rotate piping	■

Electrical

System voltage – 24 V	■
Alternator – 24 V, 100 amp	■
2 x 12 V batteries, 200 AH reserve capacity	■
Blade-type fuse panel	■
Main circuit breaker	■
Light, work (halogen): machine (8), boom (2)	■
Light, work (LED)	●
Hour meter	■
Engine restart prevention system	■
Rearview camera	■
Side view camera	●
Laptop service port	■
Self-diagnostics system	■
DEVELON Fleet Management	■

Cabin

Steel, all-weather & sound-suppressed	■
Cab riser	■
Forestry cab, side entry	●
Forestry cab, rear entry	●
Cab guard – front, top & rear	■
Viscous mount, spring-reinforced	■
Front window with wiper/washer	■
Tinted safety glass	■
Skylight	■
Front window with sun screen	■
Pull-up type top front window	■
Removable lower front window with storage behind seat	■
Adjustable sliding side door window	■
Defrost, front window	■
Lockable doors	■
Seat	
- Heated	
- Air suspension	
- 2" (51 mm) seat belt	■
- Adjustable height & recline	
- Adjustable fore/aft	
- Adjustable armrests	
3" (76 mm) seat belt	●
Control stands	
- Height adjustable	■
- Mounted to seat base	
Storage for operator's manuals	■
Fully automatic HVAC with ambient temperature sensor	■
7" multi-function LCD display monitor	■
Cigarette lighter	■
AM/FM stereo & MP3 port	■
Speakers (2)	■
Antenna, roof-mounted	■
Microphone & speaker	●
Hot/cold beverage compartment	■
Power socket, 12 V	■
Cup holder	■
Interior light	■
Coat hanger	■

Controls

Joystick controls	■
Pattern control change valve (SAE, ISO)	■
Joystick attachment control	
Switches/buttons	■
- Two-way	
Control stands	
- Height adjustable	■
- Sliding (fore/aft)	
Engine speed control dial	■
Travel pedals with hand levers	■
Switches, console-mounted	
- Starter (key)	
- Travel speed selector	■
- Work light	
- Auxiliary mode switch	
Emergency stop switch	■
Power modes (P+, P, S, E)	■
Jog dial display control	■
Wiper control panel	■
Audio control panel	■

Display Monitor & Warnings

Gauges	
- Fuel level	
- DEF level	
- Engine coolant temperature	
- Hydraulic oil temperature	
- Engine rpm	
- Battery voltage	■
- Hydraulic pump pressure	
- ECO	
- Digital clock	
- Trip meter	
- Hour meter	
- Fuel consumption	
Warning & indicator lights	
- Seat belt	
- Error code	
- SCR warning	
- Check engine	
- Engine oil pressure	
- Engine pre-heat engaged	
- Radiator coolant level & temperature	
- Air filter	■
- Fuel level	
- DEF level – low	
- Water in fuel	
- Battery charge	
- Work lights on	
- Hydraulic oil temperature	
- Hydraulic charge pressure	
- Hydraulic pilot filter	
- Hydraulic return filter	
Travel alarm	■
Buzzer	
- Engine oil pressure	■
- Coolant temperature	

Undercarriage

High-walker, high & wide fixed width	■
Track guards & chains with adjusters	■
Track rollers, upper	2
Track rollers, lower	9
In-shoe motor protection	■
Shoes, double grouser – 700 mm	■
Link, HD chain	■
Track guides, HD full-length	■

Main Frame

HD mainframe reinforcement	■
HD integrated catwalks	■
HD guarding, underbody plating	■
HD guarding, final drive motors	■
HD guarding, side doors – pump & radiator protection	■

Other

Centralized lubrication	
- Boom	■
- Arm	
- Swing	
Automatic greasing	●
Handrails & service platforms	■
Skid-resistant steps & service platforms	■
Manuals	
- Operation & Maintenance	
- Parts	■
- AEM Safety Manual	
DEVELON Fleet Management 3-year subscription	■
Vandalism protection	
- Lockable panels	■
- Lockable fluid fill points	
- Anti-theft protection (password)	

Certain specification(s) are based on engineering calculations and are not actual measurements. Specification(s) are provided for comparison purposes only and are subject to change without notice. Specification(s) for your individual DEVELON equipment will vary based on normal variations in design, manufacturing, operating conditions, and other factors. Pictures of DEVELON units may show other than standard equipment.

Powered by Innovation

DEVELON

A brand of HD Hyundai Infracore.

na.develon-ce.com/dx300ll-5

DX300LL-5 Road Builder Spec Sheet
Printed in the U.S.A.
23906_001_D092923

©2023 HD Hyundai Infracore. All rights reserved.