

# DEVELON

## Crawler Excavator

# DX235LCR-7



### Engine

Make	DEVELON
Model	DL06P
Number of cylinders	6
Rated power, gross (hp per SAE J1995)	189.1 hp (141 kW) @ 1900 rpm
Rated power, net (hp per SAE J1349)	170.3 hp (127 kW) @ 1900 rpm
Max. torque, net (SAE J1995)	593 lb.-ft. (804 Nm) @ 1400 rpm
Displacement	359 in. <sup>3</sup> (5.9 L)
Bore and stroke	3.9 in. x 4.9 in. (100 mm x 125 mm)
Starter	24 V, 8.6 hp (6.0 kW)
Battery	2 x 12 V, 100 AH
Alternator	24 V, 80 amp
Air cleaner	Two-stage

### Hydraulics

Main pumps	2 x 58.6 gpm (2 x 222 L/min.)
Pilot pump (gear design)	7 gpm (26 L/min.)

### Working Pressure

Boom/arm/bucket (normal mode)	4978 psi (350 kg/cm <sup>2</sup> )
Boom/arm/bucket (power boost)	5263 psi (370 kg/cm <sup>2</sup> )
Travel	5263 psi (370 kg/cm <sup>2</sup> )
Swing	4267 psi (300 kg/cm <sup>2</sup> )
Pilot	566 psi (40 kg/cm <sup>2</sup> )

### Undercarriage

Upper rollers (each track)	2
Lower rollers (each track)	9
Number of shoes (links per side)	49

### Swing Mechanism

Swing speed	0 – 11.5 rpm
Swing torque	69625 lb.-ft. (9626 kgf-m)

### Drive System

Travel speed (low – high)	2.0 – 3.6 mph (3.2 – 5.8 km/h)
Traction force, max. (drawbar pull)	58398 lb.-ft. (26489 kgf-m)
Max. grade (limited by engine lub)	70% (35°)

### Environment

Sound level (2000/14/EC)	103 dB(A)
Cabin sound level (ISO 6396)	72 dB(A)

### Refill Capacities

Fuel tank	81.1 gal. (307 L)
DEF tank	8.3 gal. (31.5 L)
Cooling system (radiator capacity)	8.5 gal. (32.1 L)
Engine oil (with filler)	7.1 gal. (27 L)
Swing drive	1.3 gal. (5 L)
Final drive (each side)	1.1 gal. (4 L)
Hydraulic system	50.2 gal. (190 L)
Hydraulic tank	34.3 gal. (130 L)

### Hydraulic Cylinders

Boom <sup>1</sup> (2) bore x rod diameter x stroke	5.1 in. x 3.5 in. x 53.3 in. (130 mm x 90 mm x 1355 mm)
Arm <sup>1,2</sup> (1) bore x rod diameter x stroke	5.3 in. x 3.7 in. x 58.7 in. (135 mm x 95 mm x 1490 mm)
Bucket (STD) <sup>1</sup> (1) bore x rod diameter x stroke	4.7 in. x 3.1 in. x 41.7 in. (120 mm x 80 mm x 1060 mm)

<sup>1</sup> Cushion on rod end

<sup>2</sup> Cushion on base end

The piston rods and cylinder bodies are made of high-strength steel. A shock-absorbing mechanism is fitted in all cylinders to ensure shock-free operation and extended piston life.

NOTE: Where applicable, dimensions are in accordance with Society of Automotive Engineers (SAE) and ISO standards. Specifications and design are subject to change without notice. All dimensions are given for DEVELON excavators equipped with standard tracks and the standard front as listed. Pictures of DEVELON excavators may show other than standard equipment. All dimensions are shown in inches. Respective metric dimensions are enclosed by parentheses. Rounding may impact specifications. DEVELON equipment is manufactured with a Quality Management System that is in compliance with ISO 9001:2008.

# Dimensions

		Standard Arm 31.5" (800 mm) TG Shoe (US20)	Standard Arm & Dozer Blade 24" (600 mm) TG Shoe (US40)
Boom length		18' 8" (5700 mm)	
Arm length		9' 6" (2900 mm)	
Bucket type (SAE)		1.2 yd <sup>3</sup> (0.92 m <sup>3</sup> )	
Track type		Fixed	
Tail swing radius	A <sub>1</sub>	5' 8" (1724 mm)	
Tail swing overhang (rear)	A <sub>2</sub>	-1' 8" (-501 mm)	
Tail swing overhang (side)	A <sub>3</sub>	5" (129 mm)	9" (229 mm)
Shipping height (boom)*	B	9' 9" (2871 mm)	
Shipping height (hose)*	C	9' 9" (2980 mm)	
Shipping length	D	29' 5" (8970 mm)	
Shipping width	E	10' 5" (3190 mm)	9' 9" (2990 mm)
Counterweight clearance*	F	3' 6" (1092 mm)	
Cabin height*	G	10' 2" (3123 mm)	
Upper structure width	H	9' 5" (2870 mm)	
Cabin height above house*	I	2' 3" (680 mm)	
Cabin width	J	3' 4" (1022 mm)	
Tumbler distance	K	12' 0" (3650 mm)	
Overall track length	L	14' 7" (4446 mm)	
Undercarriage width	M	10' 6" (3190 mm)	9' 9" (2990 mm)
Track gauge	N	7' 10" (2390 mm)	
Track shoe width	O	31.5" (800 mm)	24" (600 mm)
Track height*	P	2' 11" (883 mm)	
Car body clearance*	Q	1' 6" (450.5 mm)	

\*Without shoe grouser

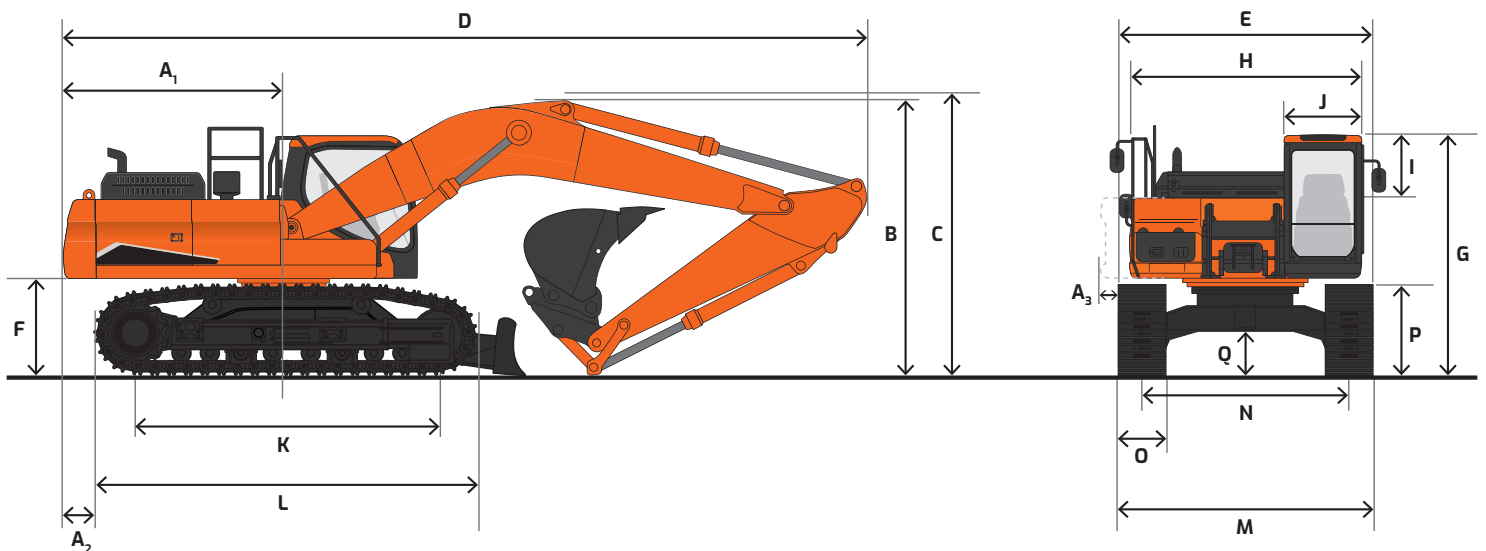

# Working Range

		Standard Arm 31.5" (800 mm) TG Shoe (US20)	Standard Arm & Dozer Blade 24" (600 mm) TG Shoe (US40)
Boom length		18' 8" (5700 mm)	
Arm length		9' 6" (2900 mm)	
Bucket type (SAE, PCSA)		1.2 yd <sup>3</sup> (0.92 m <sup>3</sup> )	
Track type		Fixed	
Max. digging reach	A	32' 3" (9830 mm)	
Max. digging reach (ground)	B	31' 8" (9645 mm)	
Max. digging depth	C	21' 11" (6680 mm)	
Max. loading height	D	26' 1" (7940 mm)	
Min. loading height	E	10' 4" (3145 mm)	
Max. digging height	F	35' 5" (10805 mm)	
Max. bucket pin height	G	30' 10" (9405 mm)	
Max. vertical wall depth	H	17' 6" (5340 mm)	
Max. radius vertical	I	21' 7" (6575 mm)	
Max. depth to 8' line	J	21' 2" (6455 mm)	
Min. radius to 8' line	K	8' 5" (2565 mm)	
Min. digging reach	L	1' 3" (375 mm)	
Min. swing radius	M	7' 7" (2310 mm)	
Bucket angle (DEG)	d	177°	
Digging force, bucket (PCSA)	ISO	36376 lbf. (16500 kgf)	
Digging force, arm		24692 lbf. (11200 kgf)	
Operating weight		58806 lb. (26730 kg)	59224 lb. (26920 kg)
Ground pressure		7.68 psi (0.54 kg/cm <sup>2</sup> )	8.0 psi (0.56 kg/cm <sup>2</sup> )

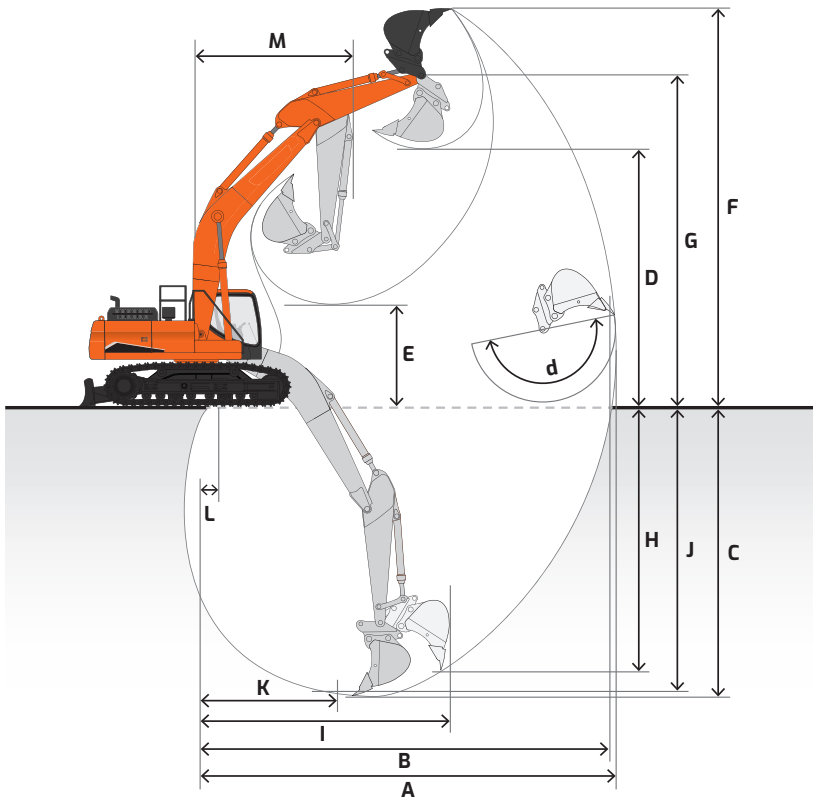

# Bucket

	Standard Arm (US20)	Standard Arm & Dozer Blade (US40)		
Boom	18' 8" (5700 mm)			
Arm	9' 6" (2900 mm)			
Shoe size	31.5" (800 mm)	24" (600 mm)		
Track type	Fixed			
Mount	Pin-on	Quick-coupler	Pin-on	Quick-coupler
Counterweight	16280 lb. (7450 kg)			

Bucket Type	Model	Capacity* yd <sup>3</sup> (m <sup>3</sup> )	Width in. (mm)	Weight lb. (kg)				
Heavy-duty	HD22-024	0.55 (0.42)	24 (610)	1394 (632)	A	A	A	A
	HD22-030	0.74 (0.57)	30 (762)	1566 (710)	A	A	A	A
	HD22-036	0.94 (0.72)	36 (914)	1747 (792)	A	A	A	A
	HD22-042	1.14 (0.87)	42 (1067)	1893 (858)	A	B	A	B
	HD22-048	1.34 (1.02)	48 (1219)	2074 (940)	B	C	B	C
Severe-duty	SD22-024	0.55 (0.42)	24 (610)	1424 (645)	A	A	A	A
	SD22-030	0.74 (0.57)	30 (762)	1586 (719)	A	A	A	A
	SD22-036	0.94 (0.72)	36 (914)	1774 (804)	A	A	A	A
	SD22-042	1.14 (0.87)	42 (1067)	1919 (870)	A	B	A	B
	SD22-048	1.34 (1.02)	48 (1219)	2097 (951)	B	C	B	C
Ditching	DC200-048	0.97 (0.74)	48 (1219)	1195 (542)	A	A	A	A
	DC200-060	1.22 (0.93)	60 (1524)	1395 (632)	A	B	A	B
	DC200-072	1.34 (1.02)	72 (1829)	1565 (709)	B	B	B	B
	HDC200-060	1.96 (1.50)	60 (1524)	2370 (1075)	C	X	C	X
	HDC200-066	2.16 (1.65)	66 (1676)	2554 (1158)	X	X	X	X

\*Capacity based on ISO 7451 and heaped with a 1:1 angle of repose

• Equipped with bolt-on wear shrouds

• Equipped with bolt-on teeth

• Equipped with bolt-on cutting edge

• These recommendations are given as a guide only and based on typical operating conditions.

#### Maximum Suitable Material Density

A 3370 lb./yd<sup>3</sup> (2000 kg/m<sup>3</sup>)

B 2700 lb./yd<sup>3</sup> (1600 kg/m<sup>3</sup>)

C 1850 lb./yd<sup>3</sup> (1100 kg/m<sup>3</sup>)

X Not Approved













Please consult with your DEVELON dealer to properly match buckets and attachments for the application.

# Lifting Capacity

 Rating over front     Rating over side or 360°

## DX235LCR-7 US20

Boom: 18' 8" (5700 mm) | Arm: 9' 6" (2900 mm) | Counterweight: 16390 lb. (7450 kg) | 31.5" (800 mm) TG Shoes | Bucket: None | Unit: lb. (kg)

A (ft. or m) B (ft. or m)	5' (1.5 m)		10' (3.0 m)		15' (4.5 m)		20' (6.0 m)		25' (7.5 m)		Max. Reach		
													A
30' (9.0 m)											* 12490 (* 5677)	* 12490 (* 5677)	14.23' (4.34 m)
25' (7.5 m)					* 13710 (* 6232)	* 13710 (* 6232)	* 11800 (* 5364)	* 11800 (* 5364)			* 10580 (* 4809)	* 10580 (* 4809)	20.3' (6.19 m)
20' (6.0 m)					* 14720 (* 6691)	* 14720 (* 6691)	* 13980 (* 6355)	12510 (5686)			* 9980 (* 4536)	9060 (4118)	23.9' (7.28 m)
15' (4.5 m)			* 23540 (* 10700)	* 23540 (* 10700)	* 17880 (* 8127)	* 17880 (* 8127)	* 15320 (* 6964)	12090 (5495)	13490 (6132)	8520 (3873)	* 9930 (* 4514)	7730 (3514)	26.08' (7.95 m)
10' (3.0 m)					* 22350 (* 10159)	17500 (7955)	* 17340 (7882)	11500 (5227)	13220 (6009)	8260 (3755)	* 10280 (* 4673)	7060 (3209)	27.21' (8.29 m)
5' (1.5 m)					* 26140 (* 11882)	16300 (7409)	17990 (8177)	10920 (4964)	12910 (5868)	7990 (3632)	11010 (5005)	6830 (3105)	27.41' (8.36 m)
Ground Level			* 14530 (* 6605)	* 14530 (* 6605)	27650 (12568)	15680 (7127)	17550 (7977)	10530 (4786)	12690 (5768)	7780 (3536)	11310 (5141)	6970 (3168)	26.71' (8.14 m)
-5' (-1.5 m)	* 15830 (* 7195)	* 15830 (* 7195)	* 24650 (* 11205)	* 24650 (* 11205)	* 27060 (* 12300)	15530 (7059)	17380 (7900)	10380 (4718)	12640 (5745)	7740 (3518)	12360 (5618)	7580 (3445)	25.03' (7.63 m)
-10' (-3.0 m)	* 26420 (* 12009)	* 26420 (* 12009)	* 33360 (* 15164)	30470 (13850)	* 24290 (* 11041)	15710 (7141)	17510 (7959)	10500 (4773)			14830 (6741)	9040 (4109)	22.14' (6.75 m)
-15' (-4.5 m)			* 24650 (* 11140)	* 24650 (* 11140)	* 18180 (* 8264)	16290 (7405)					* 14630 (* 6650)	12960 (5891)	17.41' (5.31 m)

A Distance from center of rotation  
B Height

NOTE: Lifting capacities are in compliance with SAE 1097 and ISO 10567. Machine in lifting mode with power boost turned on. Load point is the end of the arm. Rated loads shown do not exceed 75% of minimum tipping loads or 87% of hydraulic capacities. Rated loads marked with an asterisk (\*) are limited by hydraulic capacities. The least stable position is over the side. The total mass of machine includes the mass of the boom, arm, counterweight, all operating fluids and 165 lb. (75 kg) operator.

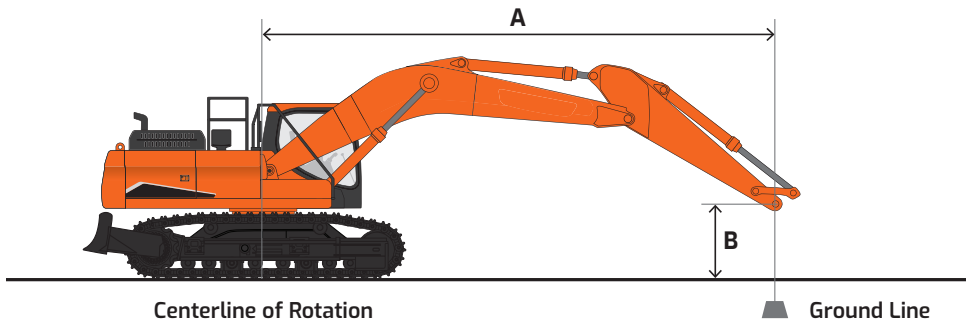













# Lifting Capacity

 Rating over front     Rating over side or 360°

## DX235LCR-7 US40

Boom: 18' 8" (5700 mm) | Arm: 7' 10" (2400 mm) | Counterweight: 16390 lb. (7450 kg) | 24" (600 mm) TG Shoes | Bucket: None | Unit: lb. (kg)

A (ft. or m) B (ft. or m)	5' (1.5 m)		10' (3.0 m)		15' (4.5 m)		20' (6.0 m)		25' (7.5 m)		Max. Reach		
													A
30' (9.0 m)											* 18040 (* 8200)	* 18040 (* 8200)	11.28' (3.44 m)
25' (7.5 m)					* 15550 (* 7068)	* 15550 (* 7068)					* 14350 (* 6523)	14220 (6464)	18.38' (5.60 m)
20' (6.0 m)					* 16410 (* 7459)	* 16410 (* 7459)	* 15220 (* 6918)	12760 (5800)			* 13320 (* 6055)	10390 (4723)	22.3' (6.80 m)
15' (4.5 m)					* 19630 (* 8923)	19180 (8718)	* 16400 (* 7455)	12400 (5636)	* 13300 (* 6045)	7910 (3680)	* 13180 (* 5591)	8740 (3973)	24.64' (7.51 m)
10' (3.0 m)					* 24010 (* 10914)	17900 (8136)	* 18270 (* 8305)	11870 (5395)	14380 (6536)	7670 (3560)	13360 (6073)	7970 (3623)	25.83' (7.87 m)
5' (1.5 m)					* 27230 (* 12377)	16910 (7686)	19620 (8918)	11380 (5173)	14140 (6427)	7400 (3430)	13020 (5918)	7720 (3509)	26.05' (7.94 m)
Ground Level					* 27950 (* 12704)	16500 (7500)	19280 (8764)	11080 (5036)	13990 (6359)	7210 (3340)	13460 (6118)	7930 (3605)	25.31' (7.71 m)
-5' (-1.5 m)		* 25120 (* 11418)	* 25120 (* 11418)	* 26550 (* 12068)	16470 (7486)	19200 (8727)	11010 (5005)				14930 (6786)	8750 (3978)	23.51' (7.17 m)
-10' (-3.0 m)		* 30340 (* 13791)	* 30340 (* 13791)	* 22910 (* 10414)	16740 (7609)	* 16740 (* 7609)	11230 (5105)				* 15700 (* 7136)	10740 (4882)	20.41' (6.22 m)
-15' (-4.5 m)		* 20160 (* 9163)	* 20160 (* 9163)	* 14560 (* 6618)	* 14560 (* 6618)						* 13900 (* 6318)	* 13900 (* 6318)	15.14' (4.61 m)

A Distance from center of rotation  
B Height

NOTE: Lifting capacities are in compliance with SAE 1097 and ISO 10567. Machine in lifting mode with power boost turned on. Load point is the end of the arm. Rated loads shown do not exceed 75% of minimum tipping loads or 87% of hydraulic capacities. Rated loads marked with an asterisk (\*) are limited by hydraulic capacities. The least stable position is over the side. The total mass of machine includes the mass of the boom, arm, counterweight, all operating fluids and 165 lb. (75 kg) operator.

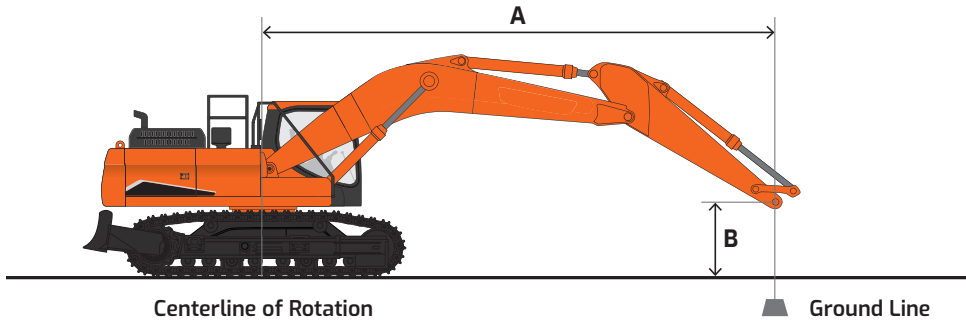

# Standard & Optional Equipment

■ Standard    ● Optional

## Engine

Emissions (EPA)	T4f
High-pressure common-rail (HPCR)	■
Turbo, waste gate (WGT)	■
Cooled exhaust gas recirculation (CEGR)	■
Diesel oxidation catalyst (DOC)	■
Selective catalyst reduction (SCR)	■
Diesel exhaust fluid (DEF)	■
Fuel filter with water separator	■
Coolant expansion tank	■
Dual element dry-type air filter with evacuator	■
Electronic engine control (ECU)	■
Auto idle	■
Auto shutdown (time-adjustable)	■
Overheat & low oil pressure engine protection	■
Block heater (110 V)	●
Water separator with heater	●
Fuel filler pump	●

## Hydraulic

Electronic Power Optimizing System (EPOS)	■
Variable axial piston main pump (tandem)	■
Cross-sensing pump control	■
Pilot-operated control valves	■
Gear pilot pump	■
Smart Power Control (SPC)	■
Variable-speed hydraulic cooling fan	■
Axial piston swing motor	■
Spring-applied hydraulic release brake, swing motor	■
Axial piston travel motor (high/low, auto)	■
Auxiliary hydraulics, one- & two-way piping	■
Auxiliary hydraulics, tilt/rotate piping	●
Adjustable auxiliary flow & pressure, 10 presets	■
Breaker filter	●
Boom & arm lock valves	●
Clamshell piping	●
Straight travel	●

## Controls

Joystick controls	■
Pattern control change valve (SAE, ISO)	■
Joystick attachment control	■
Switches/buttons	■
- Right (one-way, two-way, power boost)	■
- Left (tilt/rotate, horn, one-touch decel)	■
Foot pedal attachment control	■
Control stands	■
- Height adjustable	■
- Sliding (fore/aft)	■
- Tilting armrests	■
Engine speed control dial	■
Travel pedals with hand levers	■
Straight travel pedal	●
Switches, console-mounted	■
- Starter button switch	■
- Travel speed selector	■
- Work light	■
- Auxiliary mode switch	■
Emergency stop switch	■
Power modes (P+, P, S, E)	■
Work modes (digging, lifting, breaker, shear)	■
Smart Power Control (SPC)	■
Jog dial display control	■
Wiper control panel	■
Audio control panel	■

## Cabin

Steel, all-weather & sound-suppressed	■
ROPS (ISO 12117-2:2008)	■
Viscous mount with spring reinforcement	■
Front window with wiper/washer	■
Tinted safety glass	■
Skylight top hatch with sun screen	■
Front window with sun screen	■
Pull-up type top front window	■
Removable lower front window with storage behind seat	■
Adjustable sliding side door window	■
Defrost, front window	■
Lockable doors	■
Seat	■
- Heated	■
- Air suspension	■
- 2" (51 mm) seat belt	■
- Adjustable height & recline	■
- Adjustable fore/aft	■
- Adjustable armrests	■
Leatherette seat	■
- Heating & cooling	■
- Air suspension	■
- 2" (51 mm) seat belt	■
- Adjustable height & recline	■
- Adjustable fore/aft	■
- Adjustable armrests	■
3" (76 mm) seat belt	●
Control stands	■
- Height adjustable	■
- Mounted to seat base	■
Storage for operator's manuals	■
Mirrors	■
Fully automatic HVAC with ambient temperature sensor	■
8" multi-function LCD interactive display monitor	■
Cigarette lighter	■
Digital audio broadcasting stereo	■
Speakers (2)	■
Antenna, roof-mounted	■
Emergency breakout tool	■
Hot/cold beverage compartment	■
Power socket, 12 V & 24 V	■
Cup holder	■
Interior light	■
Coat hanger	■
Rain shield	●
Fog guard	●
Front window guard	●

## Electrical

System voltage – 24 V	■
Alternator – 24 V, 80 amp	■
Alternator – 24 V, 100 amp	■
2 x 12 V batteries, 150 AH reserve capacity, 950 CCA	■
Blade-type fuse panel	■
Main circuit breaker	■
Light, work (LED): machine (2), boom (2)	■
Light, work (LED): 6 cab top, front (4), rear (2)	●
Light, work (LED): 4 cab top, front (2), rear (2)	●
Rotating beacon	●
Overload warning alarm	●
Hour meter	■
Engine restart prevention system	■
Side view & rearview camera with LED lamps (3)	■
360° all-around view camera	●
Microphone & speaker	●
Laptop service port	■
Self-diagnostics system	■
Smart key (remote ignition key)	■
DEVELON Fleet Management	■

## Display Monitor & Warnings

Indicators	■
- Work modes (P+, P, S, E)	■
- User/Service menu	■
Gauges	■
- Fuel level	■
- DEF level	■
- Engine coolant temperature	■
- Hydraulic oil temperature	■
- Engine rpm	■
- Battery voltage	■
- Hydraulic pump pressure	■
- ECO	■
- Digital clock	■
- Trip meter	■
- Hour meter	■
- Fuel consumption	■
Warning & indicator lights	■
- Seat belt	■
- Error code	■
- SCR warning	■
- Check engine	■
- Engine oil pressure	■
- Engine pre-heat engaged	■
- Radiator coolant level & temperature	■
- Air filter	■
- Fuel level	■
- DEF level – low	■
- Water in fuel	■
- Battery charge	■
- Work lights on	■
- Hydraulic oil temperature	■
- Hydraulic charge pressure	■
- Hydraulic pilot filter	■
- Hydraulic return filter	■
Swing alarm	■
Travel alarm	■
Buzzer	■
- Engine oil pressure	■
- Coolant temperature	■

## Undercarriage

Track guards & chains with adjusters	■
Track rollers, upper	2
Track rollers, lower	9
In-shoe motor protection	■
Shoes, triple grouser – 500 mm, rubber shoe (road liner)	●
Shoes, triple grouser – 600 mm	●
Shoes, triple grouser – 700 mm	●
Shoes, triple grouser – 800 mm	■
Shoes, triple grouser – 900 mm	●
Dozer blade, front	●

## Other

Centralized lubrication	■
- Boom	■
- Swing	■
Handrails & service platforms	■
Skid-resistant steps & service platforms	■
Manuals	■
- Operation & Maintenance	■
- Parts	■
- AEM Safety Manual	■
DEVELON Fleet Management 3-year subscription	■
Vandalism protection	■
- Lockable panels	■
- Lockable fluid fill points	■
- Anti-theft protection (password)	●
- Vandalism window cover mount	■

Certain specification(s) are based on engineering calculations and are not actual measurements. Specification(s) are provided for comparison purposes only and are subject to change without notice. Specification(s) for your individual DEVELON equipment will vary based on normal variations in design, manufacturing, operating conditions, and other factors. Pictures of DEVELON units may show other than standard equipment.

# Powered by Innovation

# DEVELON

A brand of HD Hyundai Infracore.

[na.develon-ce.com/dx235lcr-7](http://na.develon-ce.com/dx235lcr-7)

DX235LCR-7 Crawler Excavator Spec Sheet  
Printed in the U.S.A.  
23906\_001\_D062123

©2023 HD Hyundai Infracore. All rights reserved.